

CARL FERDINAND BRAUN

Electrical oscillations and wireless telegraphy

Nobel Lecture, December 11, 1909

In accepting, today, the great honour and privilege of addressing the members of an Academy which though of venerable age is constantly renewed and invigorated by the contribution of fresh strength and energy, I hope for your indulgence and understanding when I conceive my task not to be that of talking about wireless telegraphy in general. I have felt it more fitting to limit myself to the narrower field of the activities in which I have been successful in taking some part in the development of the whole.

I shall ignore my experiments on the propagation of electrical waves through water which I carried out in the summer of 1898, and shall turn at once to the experiments which were described and conceived at that time as being transmission through the air.

The following should first be mentioned: Marconi, as far as I know, had begun his experiments on his father's estate in 1895, and continued them in England in 1896. His experiments in Spezia harbour were, with other ones, carried out in 1897, and a distance of 15 km was attained. In the autumn of the same year, Slaby, using much the same arrangement, reached 21 km over land but only by means of balloons to which were attached wires of 300 m in length. Why, must one ask, was it so difficult to increase the range? If the whole arrangement functioned satisfactorily over a distance of 15 km, why could not double and more the distance be attained by increasing the initial voltage, the means of doing which was available? It seemed, however, as if ever larger antennae were necessary. It was with this impression - whether the papers had correctly reported the experiments or not, I shall let pass - that I turned my attention to the subject in the autumn of 1898. I set myself the task of obtaining stronger effects from the transmitter.

If I am to give you the general thoughts and concepts which guided me I must ask you to carry yourselves back with me to the standpoint of our knowledge at that time. What facts were at our disposal and what conclusions could be drawn from them? It was known how sensitive the Hertzian oscillations were to the quality of the spark, and also that lengthening the spark led to definitely deleterious effects whereby the spark became "in-

active". Hertz had already, in his first work, called attention to the strong damping of the oscillators and compared their electrical oscillations with the ill-defined acoustic oscillations of wooden rods. Bjerknes, in 1891, had successfully measured the damping and found the logarithmic decrement (as well known the measure for damping) for a linear oscillator to be 0.26, when he used only a minute spark gap. When, however, the spark gap was increased to 5mm, the decrement rose to 0.40. This, and a series of other facts, indicated the existence of strong spark damping. All known facts became understandable if one assumed that at low capacities the spark consumed a great part of the energy, and the longer the spark was, the larger was the part of energy it consumed. On the other hand, it had long been known that the discharge of bigger capacities in the customary arcs was always oscillatory, and (in radiation-free paths) was obviously much less attenuated. In fact Feddersen had already directly photographed up to 20 half-cycles of oscillations in 1862. I took hold of this fact.

Considering the greater amounts of energy which can be collected and stored in suitable experimental form in capacitors, one could expect to deliver radiated energy for some time from them. Taken all-in-all, I concluded that if a *sparkless* antenna could be excited, from a closed Leyden-jar circuit of large capacity, into potential oscillations whose average value was that

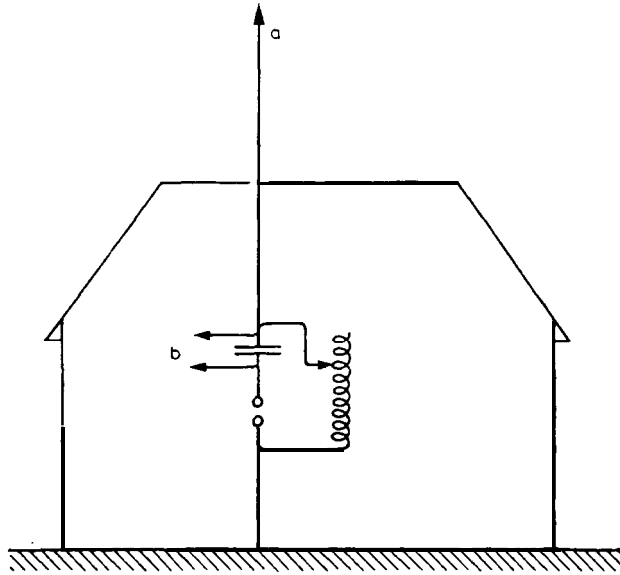

Fig. 1.

of the initial charge in a Marconi transmitter, then one would possess a more effective transmitter. There was some doubt as to whether this could be attained. And further, it was necessary to decide, by experiments on effects at a distance, whether any disturbing factor had been overlooked in these considerations. By suitable dimensioning of the exciter circuit it was found possible to fulfil the first requirement, and comparative experiments on long-distance effects were in favour of the new arrangement.

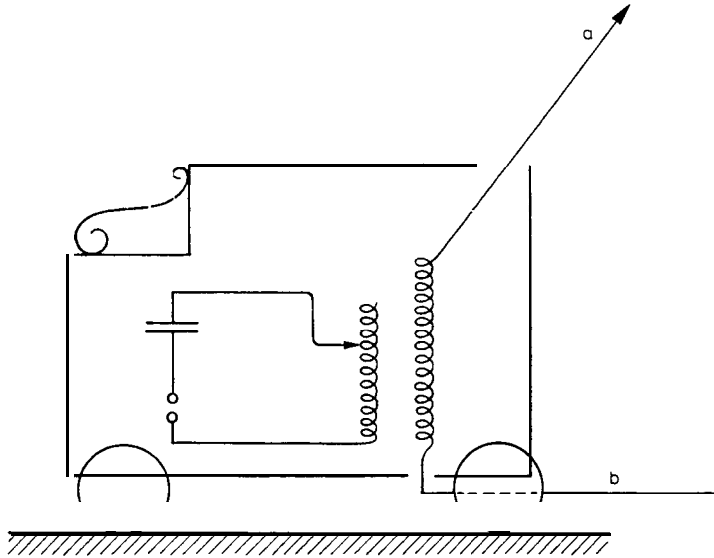

Fig. 2.

Three circuits arose from this, which I described as inductive and direct transmitter excitation, together with a mixed circuit derived from both. In Fig. 1 is shown the direct circuit. The transmitter is earthed. In Fig. 2 is shown the inductive circuit, in which Marconi's direct earthing is replaced by a "symmetry wire". This name would be entirely suitable if the complete transmitter were floating in free space (e.g., in a balloon). The transmitter would then form a half-wavelength and the excitation point, which should lie at the antinode of the current, would be in the middle. Fig. 2 shows how this circuit is adapted to a mobile station. The set-up is now unsymmetrical due to the proximity of earth. The symmetry wire can be shortened by loading its end with capacity. This arrangement is then known as a counterpoise. It disappears entirely if the connected capacity is infinitely large, that is to say, when the excitation point is on well-conducting earth.

By a suitable design of the Leyden-jar circuit, significantly higher voltages are attained in the transmitter than the charging voltage of the Leyden-jar circuit. There was some suspicion in my mind that large capacities with bigger spark lengths would behave in the same way as small capacities. At that time, little was known about this. The results of later experiments have, in part, contradicted each other, since other losses appearing with high voltages were overlooked. But as far as the spark resistance was concerned my fears, as M. Wien has recently shown, were without foundation. Since I wanted, however, to be prepared for every eventuality, I asked myself whether it might not still be possible to increase the power, for instance by connecting several circuits of the same frequency of oscillation into the excitation circuit of the transmitter. The difficulty was to so couple circuits of this kind together that they would all start to discharge at the same moment, for example within exactly $1/10$ of a millionth of a second. This task occupied me on repeated occasions. One solution, attained in a somewhat different way and to which I was led in the course of my experiments, is given here (Fig. 3). It has been described as an "energy coupling". I will touch later upon the advantages possessed by this arrangement, which remain despite the results obtained by Wien.

The experiments were to be carried further under practical conditions after Easter of 1899. The choice of location for the tests fell upon Cuxhaven. In addition to the main task there was an almost overwhelming pressure of

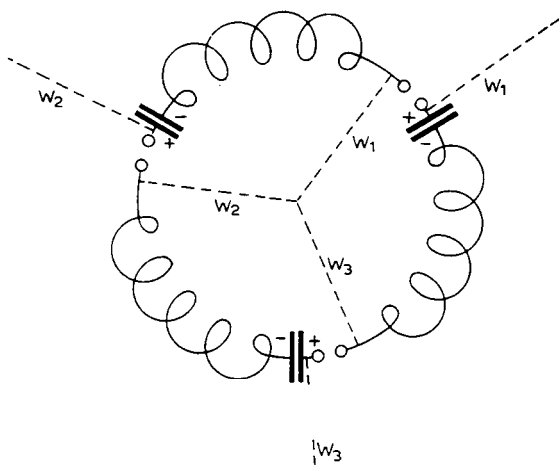

Fig. 3.

other allied tests and problems, e.g., how does the coherer work, particularly under the practical conditions occurring? Is it a resistance or does it behave like a capacitance or both? Can it be replaced by something better-defined, and if possible, more quantitatively informative? How do nearby buildings or metal masses such as masts and stays, which play such an important part in practice, affect the antenna? And there was a further multitude of problems with respect to the particular receiving apparatus. And all these problems affected the overall solution so that they all needed to be solved nearly simultaneously. Owing to my professional duties I could devote but little time to the tests, and they were carried on by two of my assistants until the autumn of 1900. The way in which the most favourable conditions were discovered in practice by systematic methods has been described by me elsewhere.

On November 16, 1900, I gave my first public lecture on this subject to the Natural Sciences Society in Strasbourg. There I described, among other matters, the advantages offered by my circuits for tuned telegraphy, advantages which Marconi had by then also recognized. On the following February 1, I demonstrated before the same Society the methods on which I had based the tuning of a receiver. I carried out more or less the same experiments before the Assembly of Research Workers in Natural Sciences in Hamburg during the autumn of the same year, as well as demonstrating the practical results on the station at Heligoland.

In the receiver, too, the most important feature was the capacitor circuit

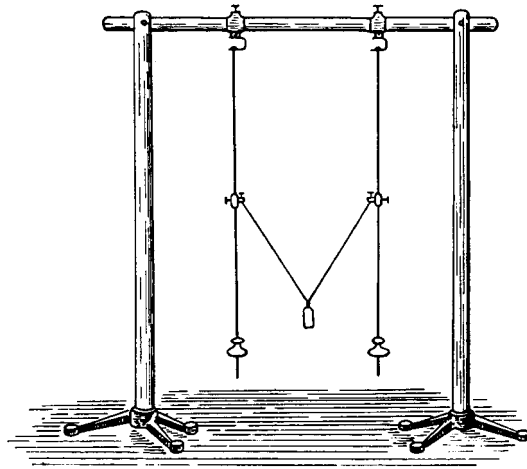

Fig. 4.

which was directly coupled to the antenna, and which, as I expressed it, collects the energy radiated towards the receiver into the best possible loss-free paths, localizes it and thus passes it onwards in the most suitable form for the detector.

By my arrangements, so-called *coupled* systems were introduced throughout in the wireless telegraphy system, and at this point we might briefly examine their properties. For preference I have used Oberbeck's pendulum model for illustration although it does not correspond completely to the electrical conditions. I produce it here (Fig. 4). Two pendulums of identical frequency are "coupled" through a loaded thread. I draw the first pendulum away from the position of rest and release it. It transmits its energy to the second pendulum and the latter increases its energy at the cost of the first, exciting pendulum. After some time the whole of the energy appears in the second pendulum. At this point, however, the process repeats itself in the opposite sequence. If I make the first pendulum heavy and the second one light, I can make the oscillation amplitude of the second greater than that of the first. The first pendulum represents the Leyden-jar circuit, the second the transmitter to which-in this case - the whole of the energy of the Leyden-jar circuit is passed. According to the ratio of the capacities the voltage can be amplified (or, if desired, reduced).

Now Oberbeck in 1895 demonstrated the following by calculation. If a capacitor circuit is allowed to operate inductively upon a second circuit of the *same* natural frequency there appear - most strikingly - *two* oscillations in both circuits, one higher and one lower than the natural frequency of oscillation. The closer the coupling, i.e., the quicker the energy transference from the first to the second circuit becomes the further apart lie the frequencies. Only for the case of infinitely loose coupling do the two oscillations approximate to the natural frequency, that is to say, become equal to each other.

This result holds also for mechanical systems, which includes our pendulums. If our two equally-tuned pendulums are coupled, then each should exhibit *two* different frequencies of oscillation. The result loses its surprise, when the phenomenon, I would like to say, is not treated mathematically but actually takes place before our eyes. The characteristic is this: the oscillations of the second pendulum increase steadily from zero upwards, then again decrease, and vice versa. We note from each pendulum what is known in acoustics as "beating". I shall recall now a method of representing graphically the acoustic beating (Fig. 5). An oscillating tuning fork carries a glass

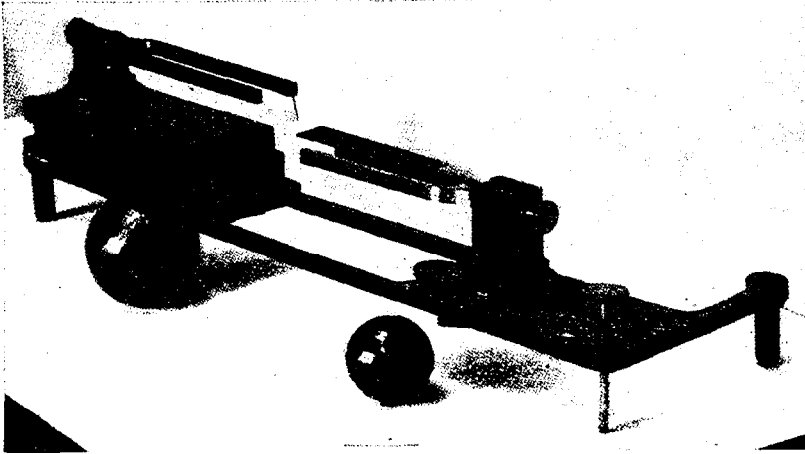

Fig. 5.

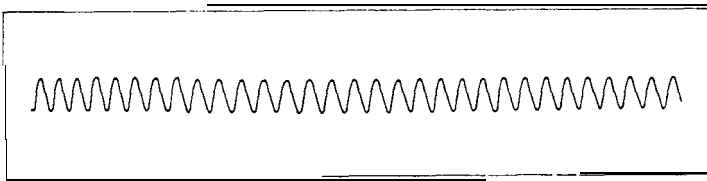

Fig. 6.

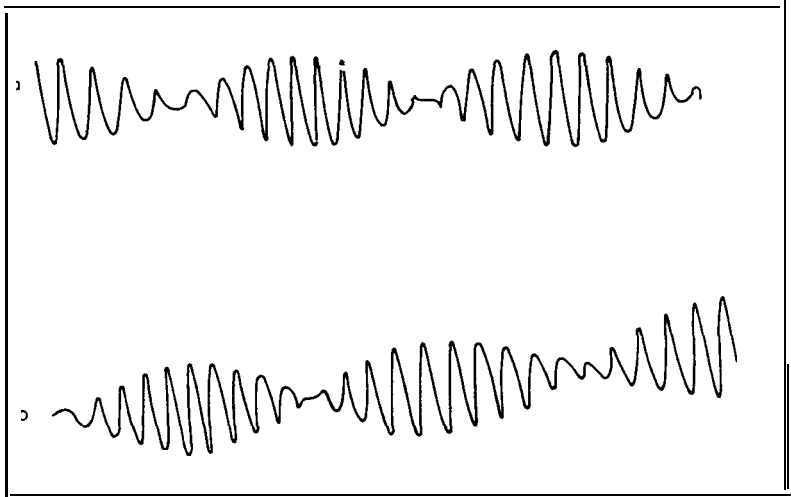

Fig. 7.

plate covered in soot (carbon black). A second tuning fork writes upon this oscillating glass plate by means of a small pin whilst it itself is drawn across the plate. One tuning fork would describe a curve of constant amplitude (Fig. 6). The oscillations of both forks are added algebraically. And when both forks have different frequencies, as is here the case, a curve as in Fig. 7 results.

I shall call them briefly "beating (or pulsating) oscillations". Just such curves would arise if we allowed our *pendulum* to write upon a moving plate. If the exciting pendulum gave the upper curve, *a*, then the excited pendulum would give the lower curve, *b*.

Each *such* beating oscillation can be considered - from the elementary laws of trigonometry - as arising from the superposition of two harmonic oscillations of different frequency, say n_1 and n_2 .

Although this is mathematically possible, however, experience teaches us that if this pulsating oscillation is applied to a structure capable of oscillation whose natural frequency fits in with one or other of the frequencies n_1 or n_2 , then it will be excited in its own natural frequency of oscillation. It selects one of the fictitious harmonic components and endows it thereby with an independent existence. A body so excited is called a resonator, and the phenomenon itself is known as resonance.

The thing is clear to the mind in the case of the tuning fork example. In space we would observe the beats, but resonators would separate the two tuning-fork tones. The application to our pendulum model is also obvious. Each part of the system performs pulsating oscillations, resonators react to two different harmonic oscillations.* If we wish (and here I return to the electrical example), to record, by means of resonators, oscillations from the radiation sent into space by the antenna, then we have to adjust the resonator to one of the two oscillations.

These electrical oscillations can be separated by means of a variable capacitor circuit, the so-called resonance Leyden-jar circuit (to which I will return later), *so long as care is taken* that as far as possible the circuit has no feed-back into the system being investigated. Oberbeck's result was concerned with the case where both system components had *closed* current circuits (with quasi-stationary flow) and were inductively coupled. It can now be easily

* If time allowed, I would be able to demonstrate both these oscillations "analytically" by means of the pendulum model. This second model, introduced by Dr. Mandelstam, and representing direct coupling through its correct mechanical analogue, allows every detail to be recognized.

shown that both oscillations also exist in the open current path of an antenna, whether it is excited directly or inductively (I am ignoring higher harmonics).

In the summer of 1902 I was able to erect two experimental stations on two forts at Strasbourg for the purpose of closer study. The task which I had set for us was to determine the most favourable conditions in the receiver. We adopted the resonant circuit, in which known capacitances were combined with calculated self-inductances, so as to bring both parts of the transmitter system into the same natural frequency of oscillation. We fixed likewise the two oscillations arising from the coupling and searched for these with the receiver. The result of the test was, for that time, surprising, as an example will show. If, by means of a coil in the receiver circuit, the oscillations were transferred inductively into a second coil located in a tuned circuit containing the indicator (parallel to a small capacitor), not only was the sharpness of the resonance but also - and here was the surprise - the *intensity* of the excitation was raised as soon as the two coils were *moved away* from one another. The intensity increased with increasing distance between the coils, though naturally beyond a certain limit there was again a decrease. Described in the customary expression, the effectiveness increased with *looser* coupling. This result in the receiver was *not* subject to a similar loose coupling in the transmitter.

There were two important results from these experiments: (a) greater freedom from disturbance in the receiver; and (b) a valuable measuring instrument for wireless engineering. When Dr. Franke of Siemens & Halske (who were working with us) saw the tests he proposed to base technically-useable equipment on them. Until then the resonance circuit had been assembled from existing parts to suit the particular requirements, and from whatever came to hand. Through the combination of a Köpsel's calibrated variable rotating capacitor and a number of calculated self-inductances, an apparatus was constructed which covered a large range of wavelengths both conveniently and continuously. The "current effect" was measured by means of a Riess's air thermometer which I had long used for intensity measurements of oscillations. The technical preparation fell to Mr. Dönitz. So arose the wave-meter, described by him and generally named after him, an apparatus which, using the theory already developed by Bjerknes in 1891, permitted simultaneously the *dumping* or attenuation of electrical waves to be measured, a quantity whose numerical value was ever more needed. There are other wave-meters with open current paths; these are simpler, but despite this the closed-circuit apparatus has because of its other advantages held the field.

By means of this instrument the foundation of measuring techniques for wireless telegraphy were laid. It soon displaced our cumbersome laboratory equipment and gave us great help in our scientific investigations, whilst it became indispensable for rational technical work in the field of electrical oscillations.

In the summer of 1902 came the publication of a theoretical study of the coupled transmitter by Max Wien. This particularly concerned the effect of damping. Wien showed by calculation the versatility of the coupled transmitter. He summed up the qualitative results of his work as follows: "According to the kind of coupling, a powerful but quickly attenuated excitation can be attained which reaches far into the distance, or alternatively a slowly decreasing wave-train which is capable of exciting a similarly-tuned resonator while passing all others by - a cannon shot to be heard afar, or a soft, slowly declining tuning-fork tone".

This theoretical investigation was most effective in clarifying the problem basically, and it will remain the foundation. It remains to be seen, however, how closely the data chosen for the numerical examples correspond to actual practice. Some calculated figures and a few laboratory figures were all that were available on the subject of damping. The field of measurements in relation to practice was beginning to be opened up. From then on, the work spread further and further outwards, branching into that of the scientific laboratories on the one hand, and the conversion of their results into practice with its complicated conditions and extensive requirements on the other. Success in the latter connection is due to Count Arco and Mr. Rendahl.

The circumstances which led me, more than ten years ago, to introduce the capacitor circuit, have altered greatly in the meantime. The Leyden-jar circuit is still to-day indispensable in wireless telegraphy. Two properties should be mentioned which I have not yet touched upon:

(1) For equal powers it is easier to design an inductor for use with high charging capacities and low voltages than vice versa. This was a determining factor at the time for the energy circuit mentioned earlier and remained so for this set-up.

(2) Insulation difficulties are practically non-existent in the Leyden-jar circuit, but the contrary is the case in the antenna circuit. If, for example, the insulators in a coupled transmitter are damp, the transmitter still works, whilst it can become impossible to charge it statically or with low frequency.

I illustrated the latter point in my lecture in November of 1900 by means of the following experiment. I allowed the transmitter to operate inductively upon a neighbouring receiver and so produced current in the latter which

brightly lit up an incandescent bulb. I touched the transmitter wire with a moist binding thread which was connected to earth. This had no effect on the operation in the case of the coupled transmitter, but the transmitter with direct inductor charging could not be operated once the damp thread was placed in contact with it.

Before I leave the subject of the coupled system I might perhaps recall an accessory which was of great use to me and other experimenters. I mean the cathode-ray tube which I described in 1897. It provided a visual picture of current- and voltage-waveforms up to 100kc/s, and was the means by which investigations of period, waveform, intensity and thereby damping, as well as relative phases, could be made.

One of the first applications of this tube was Knut Ångström's neat method of showing directly the hysteresis curve. In a similar way, the permeability of iron up to 130kc/s was investigated at the Strasbourg Institute, and a number of other problems concerned with electrical oscillations were also studied.

Three oscillograms made with the tube will serve to show its application. They illustrate the primary current pattern in the inductor, which interests us, and the significance of the capacitor therein.

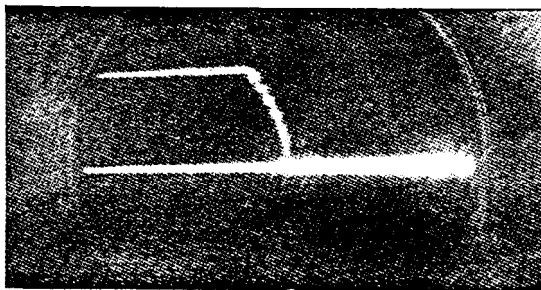

Fig. 8.

In Fig. 8 the primary current in the non-capacitive circuit falls away relatively slowly when the circuit is broken. On the other hand, if a capacitor (Fig. 9) is switched in, *oscillations* occur on breaking the circuit. The current falls much more steeply and by nearly twice the value. The secondary coil was open. If this coil circuit is closed (Fig. 10), the oscillations are faster and are attenuated more strongly.

Many applications of the tube are given in Zenneck's well-known book.

I will show you now only the current oscillations in two coupled (but strongly damped) capacitor circuits. You will see that the tubes do in fact show actual beating or pulsating oscillations (Fig. 11).

In still another place, wireless telegraphy brought me into contact with earlier investigations which I had made, this time in connection with work in my youth. I found in 1874 that materials such as galena, pyrite, pyrolusite,

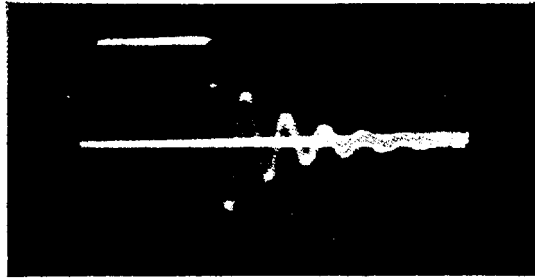

Fig. 9.

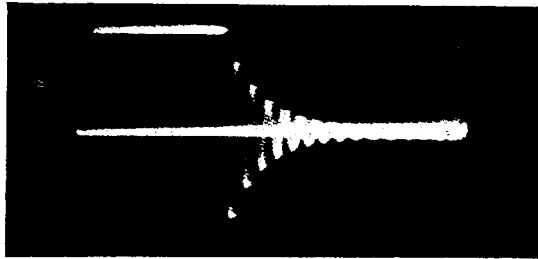

Fig. 10.

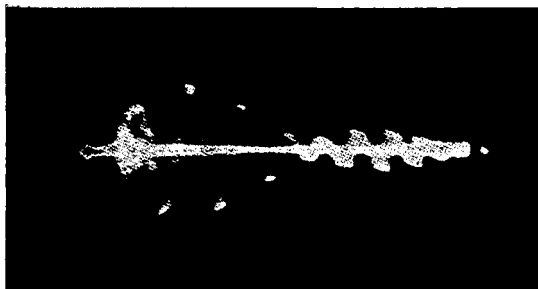

Fig. 11

tetrahedrite, etc., departed from Ohm's Law, particularly when an electrode made contact over a small surface area. These materials greatly interested me since they conduct without electrolysis although they are binary compounds. The resistance appeared to be dependent upon the direction and intensity of the current and I could, for instance, separate the opening and closing currents of a small inductor by means of such materials, in a similar way to that of a Geisler's tube. I did not succeed in finding an "explanation" for the phenomena, for instance to what material unsymmetry the electrical unsymmetries (which without doubt existed) corresponded. I had to content myself with showing that the observed phenomena were not brought about through secondary effects such as heating. I was able to demonstrate that it appeared - at least qualitatively - even in $1/500$ second, and I was convinced that - perhaps at the furthest limits - an inertialess process was concerned, a view which was supported by E. Cohn whilst carrying out some other experiments, when he found that the unsymmetrical d.c. resistance could follow current oscillations of 25kc/s . But always there remained with me a feeling of dissatisfaction, and with it, a faint memory which had obviously never died, but remained half-somnolent at the back of my mind. Instinctively I was driven back to this valve effect (with which I had repeatedly, though in vain, attempted to obtain direct current from oscillations of light) when I began to occupy myself with wireless telegraphy in 1898. The elements showed the expected detector effect, but *at that time* offered no advantages over the coherer. As the swing to aural reception of messages took place, I came back to these materials, and recognized their usefulness for this purpose in 1901. In 1905 the *Gesellschaft für drahtlose Telegraphie* (Wireless Telegraphy Co.) decided, on my recommendation, to start up a technical project in this sphere of activity. Today, these detectors - including other combinations of a similar nature - are extensively used. Pierce, by means of the cathode-ray tube, has demonstrated for slow oscillations an almost complete separation of positive and negative current components in the case of molybdenite. It seems to me that it is still an open question whether this will hold also for rapid oscillations.

I will turn now to another series of experiments.

It had always seemed most desirable to me to transmit the waves, in the main, in one direction only. I will not concern myself with the successful experiments of this kind made at the Strasbourg Forts in 1901, since it came out later that similar proposals had already been made by others.

I found in 1902 that an antenna, inclined at somewhat less than 10° to the horizon, formed a kind of directional receiver. The receptivity showed a clearly defined maximum for waves passing through the vertical plane in which the antenna was situated. The results were published in March of 1903.

A directional transmitter is made up in the following way (Fig. 12). It is assumed that the antennae A and B, located at comers of an equilateral triangle, are equal in phase, but are *delayed* by a quarter of a cycle of oscillation relative to antenna C, which is in the third comer. The height CD of the triangle is to be a quarter wavelength. The radiation will then prefer the direction CD. The wave emanating from C will reach AB at the moment that A and B start to oscillate.

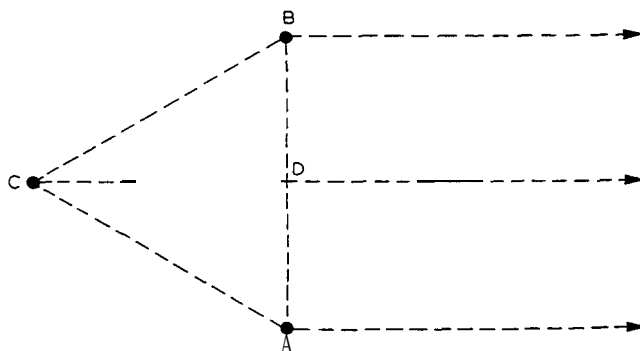

Fig. 12.

The task arose to attain this kind of phase difference for rapid oscillations, and prior to this, to measure such differences. A measuring method came easily to hand, one which has also proved itself in practical experiments. The solution of the other task did not go well using the scheme which I had thought out. On the other hand, two of my assistants found an ingenious solution when they took up the work, at my suggestion, in the Strasbourg Institute. Experiments were carried out on a big parade-ground in the vicinity of Strasbourg (spring of 1905).

In Fig. 13 is shown, schematically, the layout used. The field was measured at a fair distance away, that is to say, in the so-called wave-zone. There was satisfactory agreement between theory and observation, and the results were checked in various ways. It was further shown that the experimental layout functioned in the desired sense. By suitable distribution of the amplitudes in the three transmitters, a field as in Fig. 14 was calculated (the

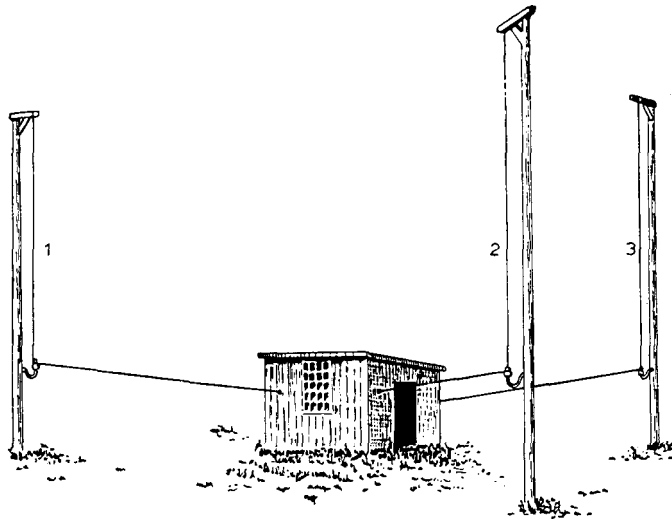

Fig. 13.

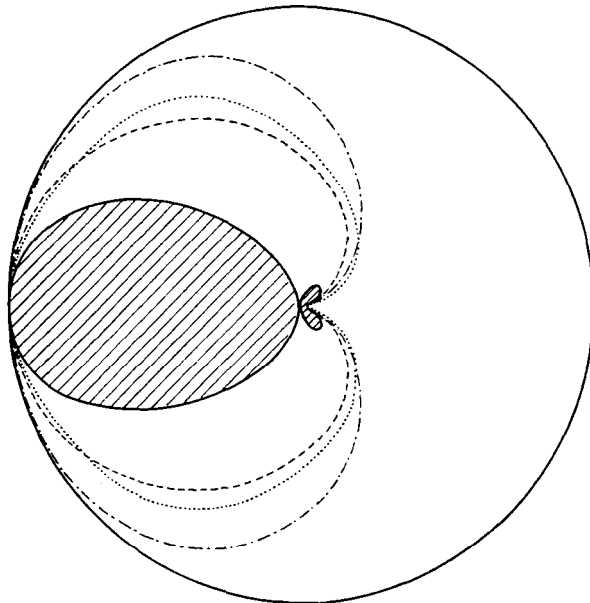

Fig. 14.

singly dotted curve is the measured field). The radial vectors represent the range. If the roles of the three transmitters are exchanged - by simply tripping a change-over switch - the preferred direction can be rotated through 120° or 60° .

It would appear to be of general interest to remark that one is led to the conclusion that the radiation of a transmitter is reduced here by the oscillations in its neighbour, which are shifted in position and phase, a conclusion which could be proved experimentally.

If nowadays optical phenomena are ascribed to electrical molecular resonators, then electrical processes, as demonstrated here by a single example, can also be linked up with optical phenomena, though this can hardly be experimentally verified in this field.

Here, the study of electrical oscillations supplements that of optical oscillations, and since we are in the position to tackle a problem in either field by analogy with a phenomenon which is comprehended in the other field, the first attack on the problem can be made from the electrical or the optical standpoint according to whichever presents the easier concept to realize. I can perhaps illustrate this by means of two worked-out examples.

Elementary considerations led me to the conclusion that a medium, composed of layers of different dielectric constants, must behave as a uniaxial crystal if it is assumed that the layer thicknesses are only a fraction of a wavelength. I was able to confirm this conclusion in the following way (Fig. 15). A beam of practically parallel electrical rays emerges from the Hertzian reflector. It strikes a structure made of bricks in layers having the same breadth of air layers. These layers lie open to short waves, but if the wavelength is 12 times, or so, longer than the layer thickness, then the brick grating behaves towards it as a body which homogeneously occupies the space but exhibits double refraction. The electrical oscillations are linearly polarized and incident at an azimuth of 45° upon the brick layers. A brick structure which is



Fig.15.

about $2\frac{1}{2}$ times the thickness of a single brick has the effect of a quarter-wave foil of mica, and the linearly-incident ray emerges circularly polarized as we deduce from the investigations with a Righi's resonator. Assume it is right-handed circular. If the layer thickness is now doubled, the emergent wave is again linearly polarized, though in the other quadrant. And so we can transform the ray, by continuous addition of further thicknesses, into a left-handed circular one, and finally back into a ray which is linearly polarized parallel to the incident ray. The double refraction of the brick grating surpasses that of calcite. Optically, this brick structure would correspond to a tiny crystal of a few thousandths of a millimetre length of edge, but electrically it is $2\frac{1}{2}$ metres thick, weighs 4000 kg, and its raw material is worth about 200 marks. The analogue of a corresponding optical phenomenon was also demonstrated by me at a later date.

This phenomenon of double refraction does not depend upon the use of rigid materials. Whether the double refraction occurring in cross-striated muscle results from a similar layer structure is thus a closely related question.

We have so far studied an electrically unknown, but optically conjectured phenomenon and both have been discovered to exist. The following example is concerned with demonstrating the unknown optical phenomenon corresponding to a known electrical phenomenon. It seemed to me to be of interest to reproduce the Hertzian grid experiment in the field of visible rays. For this to be realized, a very fine grating of metal wires was necessary and from 10,000 to 100,000 tiny wires, separated by air gaps, had to be located within a width of 1 mm. Mechanical methods of manufacture are impossible, but a Hertzian grid could be made in the following way. If a powerful discharge is passed through a thin metal wire on a glass plate, or between two such plates, the well-known sputtering or vaporization effect occurs, as you can see from Fig.16. The metal wire vaporizes (temperatures of up to $30,000^{\circ}$

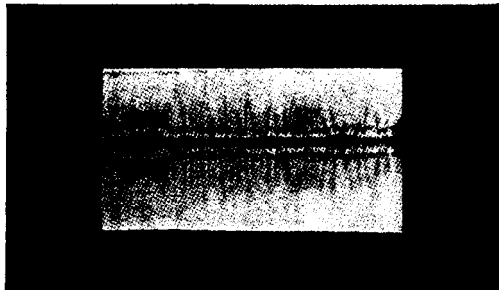

Fig. 16.

are calculated). The metal vapour is driven outwards by the pressure arising from the explosive effect (Fig. 17) and is then again precipitated obviously in a kind of grid structure on the glass. If we allow linearly polarized light to fall upon the prepared surface, it will, if the oscillations are parallel to the lines of the grid, be strongly reflected and strongly absorbed—the preparation appears dark (Fig. 18). If the plane of the oscillations is turned so that it is perpendicular to the lines of the grid, the metal layer becomes transparent

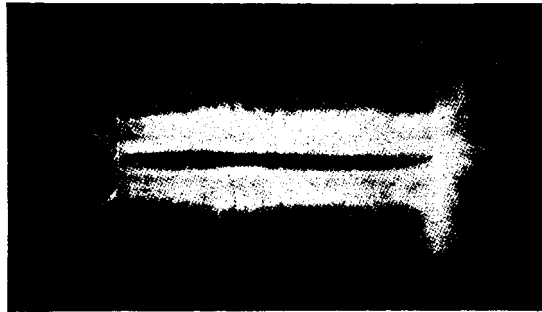

Fig. 17.

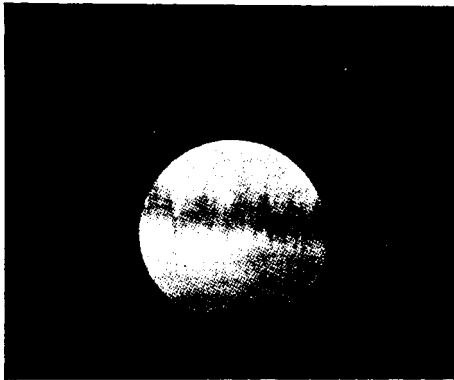

Fig. 18.

(Fig. 19). We have the complete optical analogue to a Hertzian grid made out of moderately good conductors.

This experiment permits a further development. If we imagine that in an organized fabric such as muscle tissue, plant fibres, etc. there exists a similar fine grating structure somewhat in the form of the finest possible channels, then if we could succeed in filling these with metal, the preparation would have the optical effect of a Hertzian grid. H. Ambrohn, in 1896, treating the

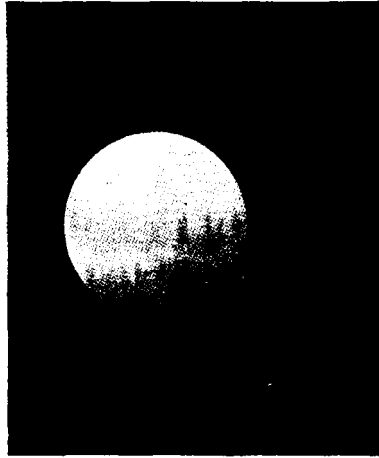

Fig. 19.

above mentioned substances with gold or silver salts, discovered phenomena which I explained in this way. In an exhaustive investigation into this matter I have everywhere found confirmation of my concept, and nowhere a contradiction. Yet a direct and incontrovertible proof would be extremely desirable because of the importance of its consequences. For if my idea is, as I believe, correct, then we would in this way not only discover sub-microscopic gratings, but, as a result of electrical imitation, we would even be able to some extent to make a picture of the material structure which is as yet invisible to the human eye. This method would augment those so far available in a most valuable manner, for it takes its place just where the microscope and -because of the density of the particles - even the ultramicroscope, reach the limit of their capacity.

I must now finish this address. The sputtering experiments led me back to the Leyden-jar circuit. I pursued for a long time the aim of automatically switching out the Leyden-jar circuit from the oscillating system as soon as it had given up its energy to the secondary conductor. I attempted this in the following way. A thin wire was connected into the Leyden-jar circuit, and I hoped that, at the right moment, the primary circuit would be switched out as a result of vaporization of the wire. The experiment was not successful, at any rate at the frequencies which I used, apparently because the highly heated metal vapour remained ionized for too long a time. The problem was solved, however, by Max Wien using the so-called quenched spark, and by Rendahl using the mercury spark-gap. Practical experience has augmented

Wien's discovery. Arising from this and through the agency of Rendahl and Arco, came the so-called tone-spark. The small hissing or quenched sparks of Wien of itself meet the conditions which I had hoped to produce artificially. The Leyden-jar circuit cuts itself out at the most suitable moment, and the greater part of the primary energy then oscillates in the highly conductive paths in the transmitter at its own natural frequency.

On the occasion of my first lecture in November 1900 I closed with the following words:

"Sometimes, wireless telegraphy has been described as spark telegraphy, and so far a spark in one place or another has been unavoidable. Here, however, it has been made as harmless as possible. This is *important*. For the spark which produces the waves also destroys them again as Saturn destroyed his own children. What was pursued here could be truthfully described as *sparkless telegraphy*."

Finishing as I did with these words at that time, I feel happy to think that with the means I have described we have come appreciably nearer to this target, and have thereby made the coupled transmitter still more effective.